

HA17431 Series

Shunt Regulator

REJ03D0678-0300

Rev.3.00

Apr 03, 2007

Description

The HA17431 series is temperature-compensated variable shunt regulators. The main application of these products is in voltage regulators that provide a variable output voltage. The on-chip high-precision reference voltage source can provide $\pm 1\%$ accuracy in the V versions, which have a V_{KA} max of 16 volts. The HA17431VLP, which is provided in the MPAK-5V package, is designed for use in switching mode power supplies. It provides a built-in photocoupler bypass resistor for the PS pin, and an error amplifier can be easily constructed on the supply side.

Features

- The V versions provide $2.500\text{ V} \pm 1\%$ at $T_a = 25^\circ\text{C}$
- The HA17431VLP includes a photocoupler bypass resistor ($2\text{ k}\Omega$)
- The reference voltage has a low temperature coefficient
- The MPAK-5V(5-pin), MPAKV(3-pin) and UPAKV miniature packages are optimal for use on high mounting density circuit boards

Block Diagram

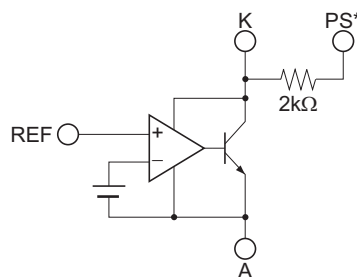

Note: * The PS pin is only provided by the HA17431VLP.

Application Circuit Example

Switching power supply secondary-side error amplification circuit

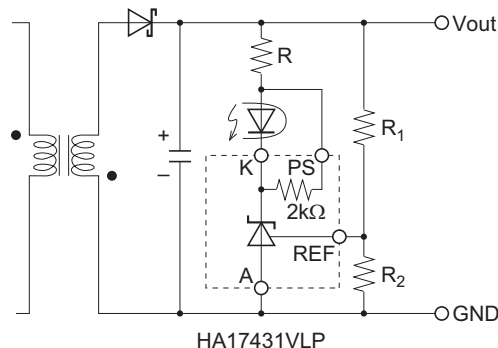

Ordering Information

| Item | | Reference voltage (at 25°C) | | | Package Code (Package Name) | Operating Temperature Range |
|-------------------|-------------|---|--|--|--------------------------------|-----------------------------------|
| | | Normal Version ±4% 2.395V to 2.495V to 2.595V | A Version ±2.2% 2.440V to 2.495V to 2.550V | V Version ±1% 2.475V to 2.500V to 2.525V | | |
| Industrial use | HA17431FP | ○ | | | PRSP0008DE-B (FP-8DGV) | -20 to +85°C |
| | HA17431FPA | | ○ | | PRSP0008DE-B (FP-8DGV) | |
| | HA17431P | ○ | | | PRSS0003DC-A (TO-92MODV) | |
| | HA17431PA | | ○ | | PRSS0003DC-A (TO-92MODV) | |
| | HA17431PNA | | ○ | | PRSS0003DA-A (TO-92V) | |
| | HA17431VLP | | | ○ | PLSP0005ZB-A (MPAK-5V) | |
| | HA17431VP | | | ○ | PRSS0003DA-A (TO-92V) | |
| | HA17431VUP | | | ○ | PLZZ0004CA-A (UPAKV) | |
| | HA17432VUP | | | ○ | PLZZ0004CA-A (UPAKV) | |
| | HA17431VLTP | | | ○ | PLSP0003ZB-A (MPAKV) | |
| | HA17432VLTP | | | ○ | PLSP0003ZB-A (MPAKV) | |
| Commercial use | HA17431UA | | ○ | | PLZZ0004CA-A (UPAKV) | -20 to +85°C |
| | HA17432UA | | ○ | | PLZZ0004CA-A (UPAKV) | |

Pin Arrangement

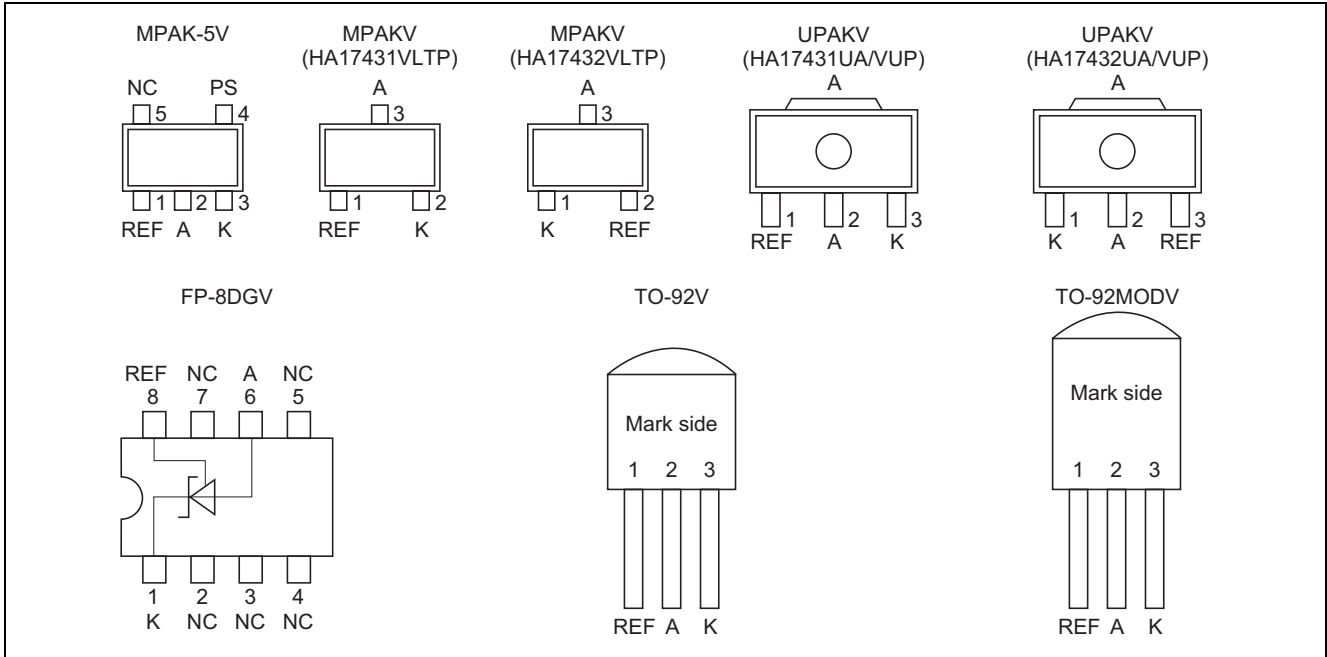

Absolute Maximum Ratings

(Ta = 25°C)

| Item | Symbol | Ratings | | Unit | Notes |
|-----------------------------|------------------|-----------------------|--------------------|------|-------|
| | | HA17431VLP | HA17431VP | | |
| Cathode voltage | V _{KA} | 16 | 16 | V | 1 |
| PS term. voltage | V _{PS} | V _{KA} to 16 | — | V | 1,2,3 |
| Continuous cathode current | I _K | -50 to +50 | -50 to +50 | mA | |
| Reference input current | I _{ref} | -0.05 to +10 | -0.05 to +10 | mA | |
| Power dissipation | P _T | 150 * ⁴ | 500 * ⁵ | mW | 4, 5 |
| Operating temperature range | Topr | -20 to +85 | -20 to +85 | °C | |
| Storage temperature | Tstg | -55 to +150 | -55 to +150 | °C | |

| Item | Symbol | Ratings | | Unit | Notes |
|-----------------------------|------------------|-----------------------|-------------------------|------|-------|
| | | HA17431VUP/HA17432VUP | HA17431VLTP/HA17432VLTP | | |
| Cathode voltage | V _{KA} | 16 | 16 | V | 1 |
| PS term. voltage | V _{PS} | — | — | V | 1,2,3 |
| Continuous cathode current | I _K | -50 to +50 | -50 to +50 | mA | |
| Reference input current | I _{ref} | -0.05 to +10 | -0.05 to +10 | mA | |
| Power dissipation | P _T | 800 * ⁸ | 150 * ⁴ | mW | 4, 8 |
| Operating temperature range | Topr | -20 to +85 | -20 to +85 | °C | |
| Storage temperature | Tstg | -55 to +150 | -55 to +150 | °C | |

| Item | Symbol | Ratings | | Unit | Notes |
|-----------------------------|------------------|--------------------|--------------------|------|-------|
| | | HA17431PNA | HA17431P/PA | | |
| Cathode voltage | V _{KA} | 40 | 40 | V | 1 |
| Continuous cathode current | I _K | -100 to +150 | -100 to +150 | mA | |
| Reference input current | I _{ref} | -0.05 to +10 | -0.05 to +10 | mA | |
| Power dissipation | P _T | 500 * ⁵ | 800 * ⁶ | mW | 5, 6 |
| Operating temperature range | Topr | -20 to +85 | -20 to +85 | °C | |
| Storage temperature | Tstg | -55 to +150 | -55 to +150 | °C | |

| Item | Symbol | Ratings | | Unit | Notes |
|-----------------------------|------------------|--------------------|---------------------|------|-------|
| | | HA17431FP/FPA | HA17431UA/HA17432UA | | |
| Cathode voltage | V _{KA} | 40 | 40 | V | 1 |
| Continuous cathode current | I _K | -100 to +150 | -100 to +150 | mA | |
| Reference input current | I _{ref} | -0.05 to +10 | -0.05 to +10 | mA | |
| Power dissipation | P _T | 500 * ⁷ | 800 * ⁸ | mW | 7, 8 |
| Operating temperature range | Topr | -20 to +85 | -20 to +85 | °C | |
| Storage temperature | Tstg | -55 to +125 | -55 to +150 | °C | |

Notes: 1. Voltages are referenced to anode.

2. The PS pin is only provided by the HA17431VLP.

3. The PS pin voltage must not fall below the cathode voltage. If the PS pin is not used, the PS pin is recommended to be connected with the cathode.

4. Ta ≤ 25°C. If Ta > 25°C, derate by 1.2 mW/°C.

5. Ta ≤ 25°C. If Ta > 25°C, derate by 4.0 mW/°C.

6. Ta ≤ 25°C. If Ta > 25°C, derate by 6.4 mW/°C.

7. 50 mm × 50 mm × 1.5mm glass epoxy board (5% wiring density), Ta ≤ 25°C. If Ta > 25°C, derate by 5 mW/°C.

8. 15 mm × 25 mm × 0.7mm alumina ceramic board, Ta ≤ 25°C. If Ta > 25°C, derate by 6.4 mW/°C.

Electrical Characteristics

HA17431VLP/VP/VUP/VLTP, HA17432VUP/VLTP

(Ta = 25°C, IK = 10 mA)

| Item | Symbol | Min | Typ | Max | Unit | Test Conditions | Notes |
|---|--------------------------------|-------|----------|-------|--------|---|-------|
| Reference voltage | Vref | 2.475 | 2.500 | 2.525 | V | VKA = Vref | |
| Reference voltage temperature deviation | Vref(dev) | — | 10 | — | mV | VKA = Vref, Ta = -20°C to +85°C | 1 |
| Reference voltage temperature coefficient | $\Delta V_{ref}/\Delta T_a$ | — | ± 30 | — | ppm/°C | VKA = Vref, 0°C to 50°C gradient | |
| Reference voltage regulation | $\Delta V_{ref}/\Delta V_{KA}$ | — | 2.0 | 3.7 | mV/V | VKA = Vref to 16 V | |
| Reference input current | Iref | — | 2 | 6 | μA | R1 = 10 kΩ, R2 = ∞ | |
| Reference current temperature deviation | Iref(dev) | — | 0.5 | — | μA | R1 = 10 kΩ, R2 = ∞, Ta = -20°C to +85°C | |
| Minimum cathode current | Imin | — | 0.4 | 1.0 | mA | VKA = Vref | 2 |
| Off state cathode current | Ioff | — | 0.001 | 1.0 | μA | VKA = 16 V, Vref = 0 V | |
| Dynamic impedance | ZKA | — | 0.2 | 0.5 | Ω | VKA = Vref, IK = 1 mA to 50 mA | |
| Bypass resistance | RPS | 1.6 | 2.0 | 2.4 | kΩ | Ips = 1 mA | 3 |
| Bypass resistance temperature coefficient | $\Delta R_{PS}/\Delta T_a$ | — | +2000 | — | ppm/°C | Ips = 1 mA, 0°C to 50°C gradient | 3 |

HA17431P/PA/FP/FPA/PNA/UA, HA17432UA

(Ta = 25°C, IK = 10 mA)

| Item | Symbol | Min | Typ | Max | Unit | Test Conditions | Notes |
|---|--------------------------------|-------|-------|-------|------|---------------------------------------|--------|
| Reference voltage | Vref | 2.440 | 2.495 | 2.550 | V | VKA = Vref | A |
| | | 2.395 | 2.495 | 2.595 | | | Normal |
| Reference voltage temperature deviation | Vref(dev) | — | 5 | (17) | mV | VKA = Vref, Ta = 0°C to +70°C | 1, 4 |
| Reference voltage regulation | $\Delta V_{ref}/\Delta V_{KA}$ | — | 1.4 | 3.7 | mV/V | VKA = Vref to 10 V | |
| | | — | 1 | 2.2 | | VKA = 10 V to 40 V | |
| Reference input current | Iref | — | 3.8 | 6 | μA | R1 = 10 kΩ, R2 = ∞ | |
| Reference current temperature deviation | Iref(dev) | — | 0.5 | (2.5) | μA | R1 = 10 kΩ, R2 = ∞, Ta = 0°C to +70°C | 4 |
| Minimum cathode current | Imin | — | 0.4 | 1.0 | mA | VKA = Vref | 2 |
| Off state cathode current | Ioff | — | 0.001 | 1.0 | μA | VKA = 40 V, Vref = 0 V | |
| Dynamic impedance | ZKA | — | 0.2 | 0.5 | Ω | VKA = Vref, IK = 1 mA to 100 mA | |

Notes: 1. Vref(dev) = Vref(max) – Vref(min)

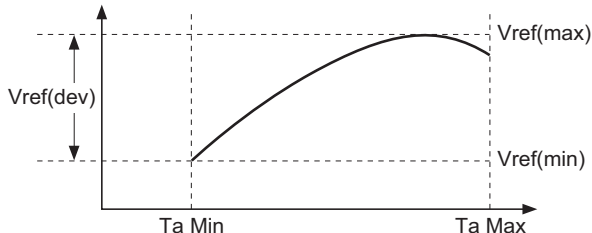

- 2. Imin is given by the cathode current at Vref = Vref(IK=10mA) – 15 mV.
- 3. RPS is only provided in HA17431VLP.
- 4. The maximum value is a design value (not measured).

MPAK-5V(5-pin), MPAKV(3-pin) and UPAKV Marking Patterns

The marking patterns shown below are used on MPAK-5V, MPAKV and UPAKV products. Note that the product code and mark pattern are different. The pattern is laser-printed.

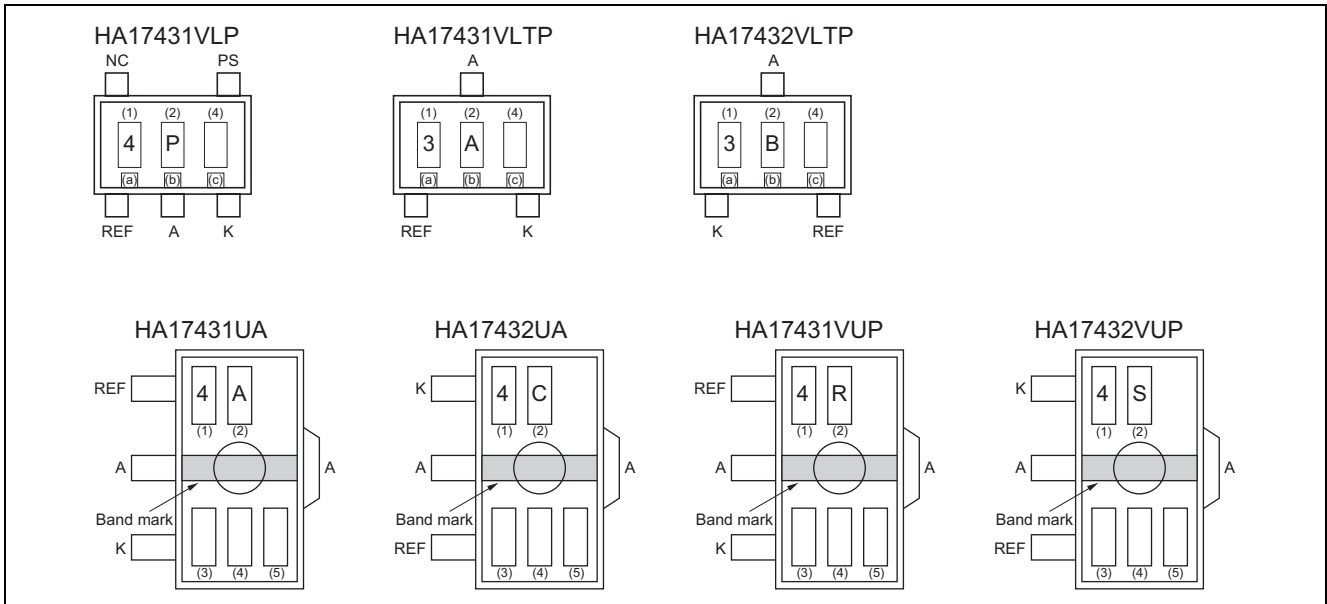

- Notes: 1. Boxes (1) to (5) in the figures show the position of the letters or numerals, and are not actually marked on the package.
 2. The letters (1) and (2) show the product specific mark pattern.

| Product | (1) | (2) |
|-------------|-----|-----|
| HA17431VLP | 4 | P |
| HA17431VUP | 4 | R |
| HA17432VUP | 4 | S |
| HA17431VLTP | 3 | A |
| HA17432VLTP | 3 | B |
| HA17431UA | 4 | A |
| HA17432UA | 4 | C |

3. The letter (3) shows the production year code (the last digit of the year) for UPAKV products.
 4. The bars (a), (b) and (c) show a production year code for MPAK-5V and MPAKV products as shown below. After 2015 the code is repeated every 8 years.

| Year | 2007 | 2008 | 2009 | 2010 | 2011 | 2012 | 2013 | 2014 |
|------|------|------|------|------|------|------|------|------|
| (a) | Bar | Bar | None | None | None | None | Bar | Bar |
| (b) | Bar | Bar | None | None | Bar | Bar | None | None |
| (c) | None | Bar | None | Bar | None | Bar | None | Bar |

5. The letter (4) shows the production month code (see table below).

| Production month | Jan. | Feb. | Mar. | Apr. | May. | Jun. | Jul. | Aug. | Sep. | Oct. | Nov. | Dec. |
|------------------|------|------|------|------|------|------|------|------|------|------|------|------|
| Marked code | A | B | C | D | E | F | G | H | J | K | L | M |

6. The letter (5) shows manufacturing code. For UPAKV products.

Characteristics Curves

HA17431VLP/VP/VUP/VLTP, HA17432VUP/VLTP

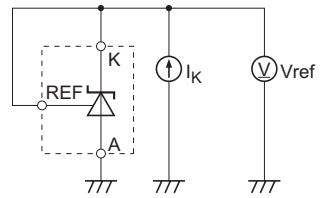
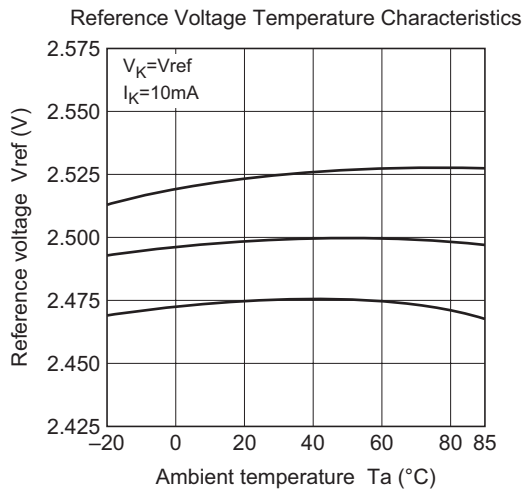

Cathode Current vs. Cathode Voltage Characteristics 1

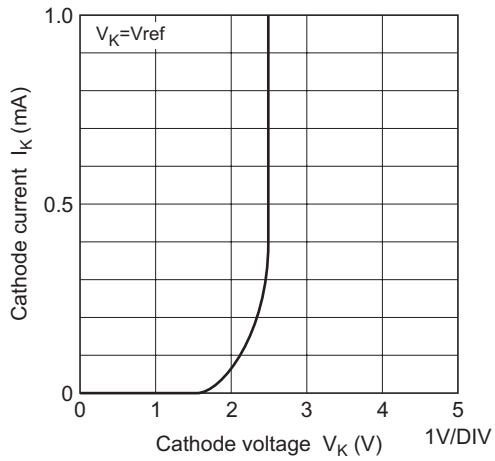

Cathode Current vs. Cathode Voltage Characteristics 2

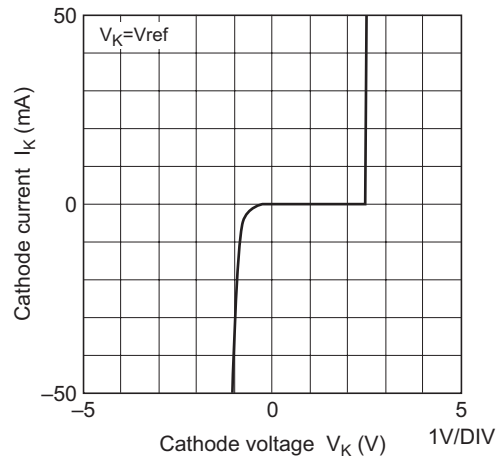

Dynamic Impedance vs. Frequency Characteristics

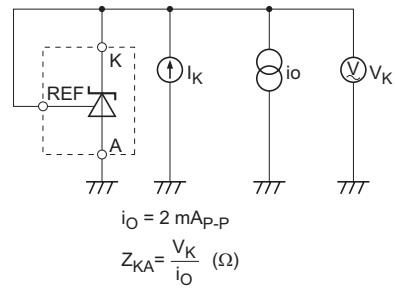
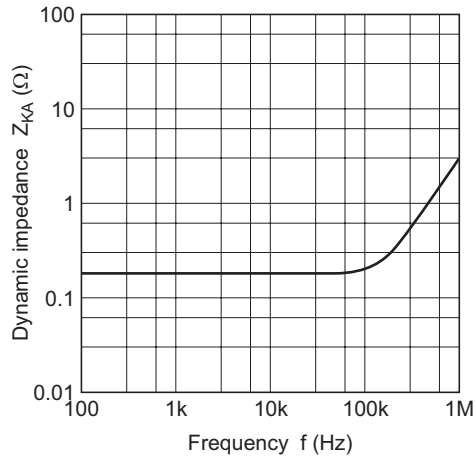

Open Loop Voltage Gain, Phase vs. Frequency Characteristics

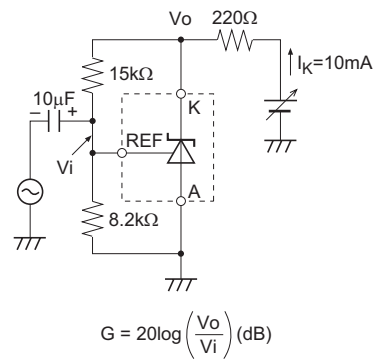
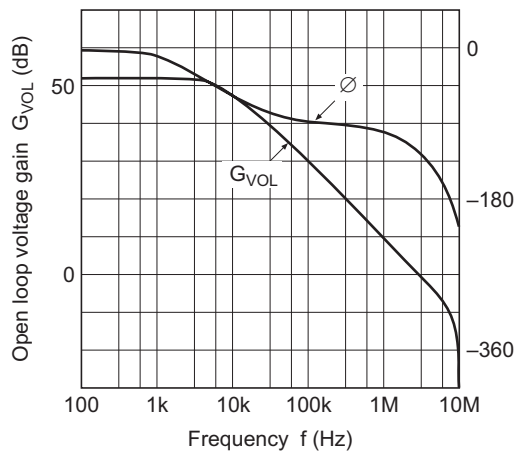

HA17431P/PA/FP/FPA/PNA/UA, HA17432UA

Oscillation Stability vs. Load Capacitance between Anode and Cathode

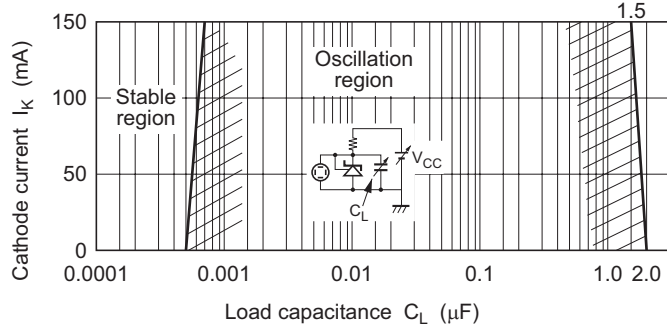

Open Loop Voltage Gain, Phase vs. Frequency Characteristics (1)
(With no feedback capacitance)

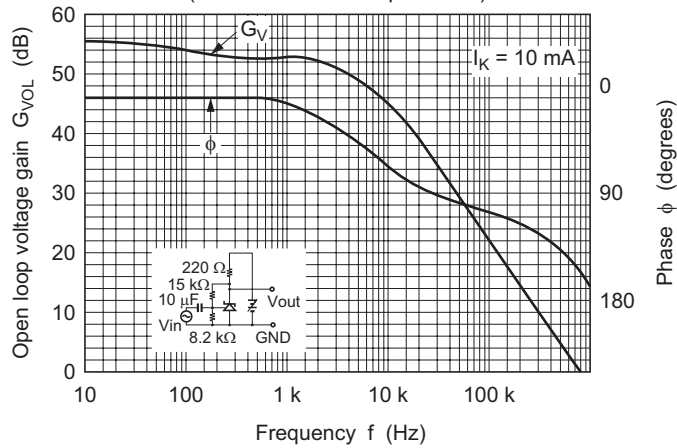

Open Loop Voltage Gain, Phase vs. Frequency Characteristics (2)
(When a feedback capacitance (Cf) is provided)

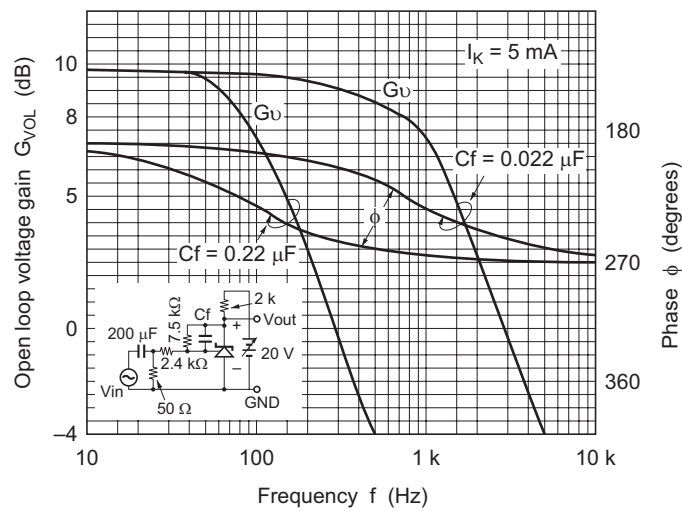

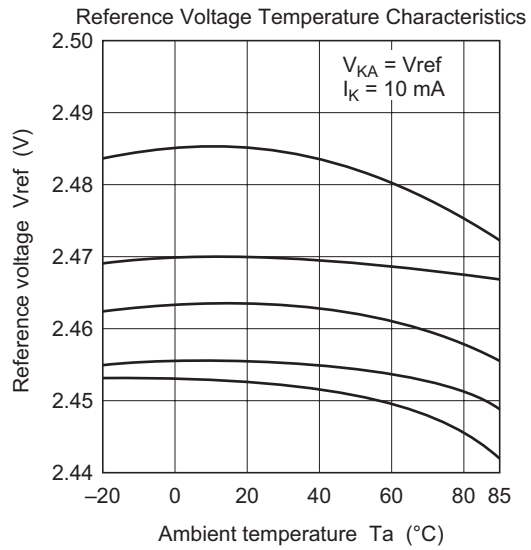
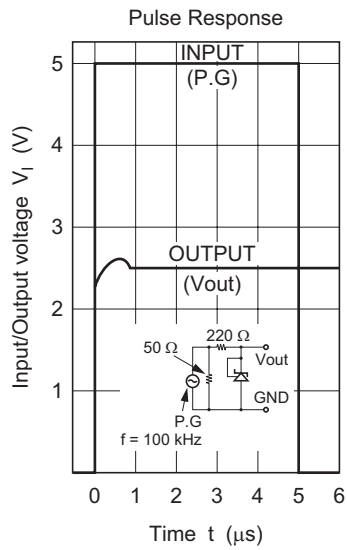
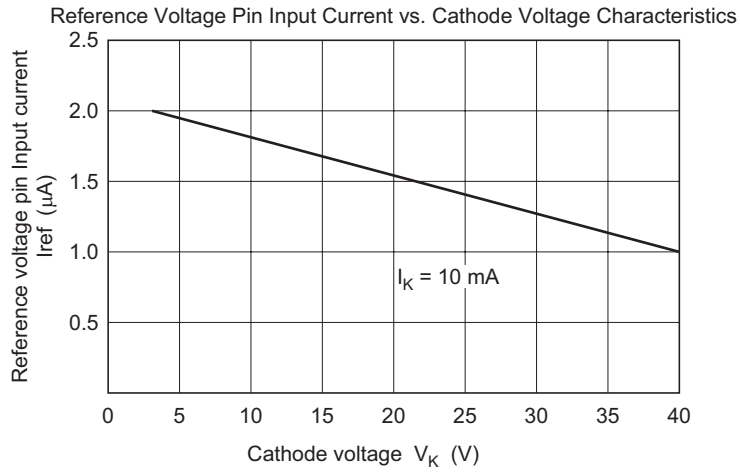

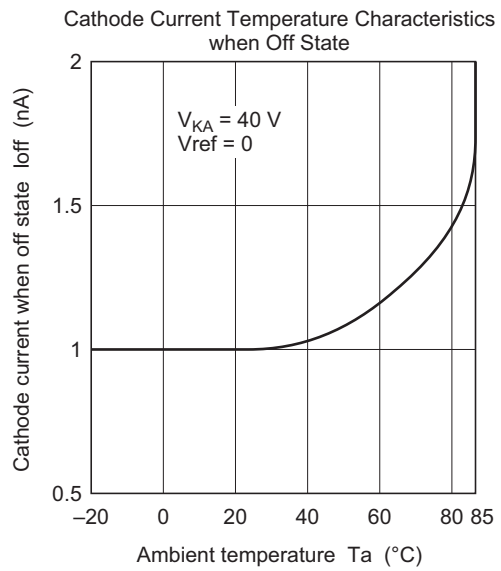
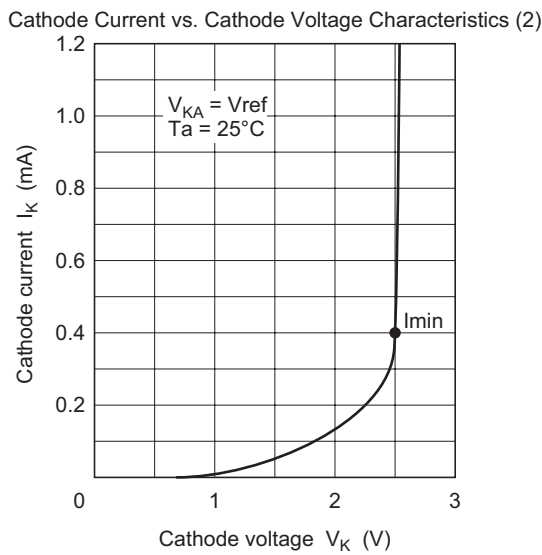
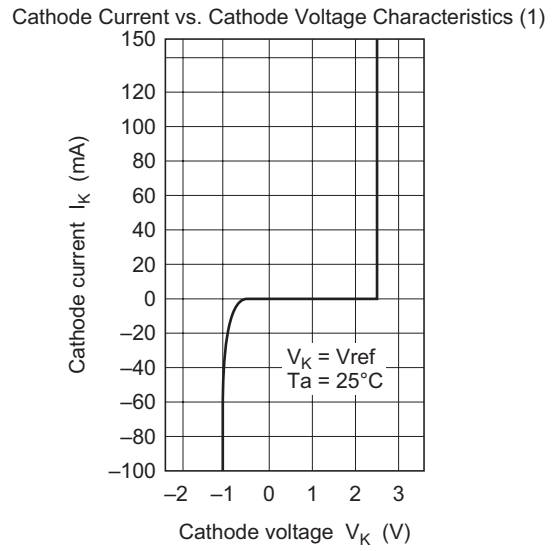
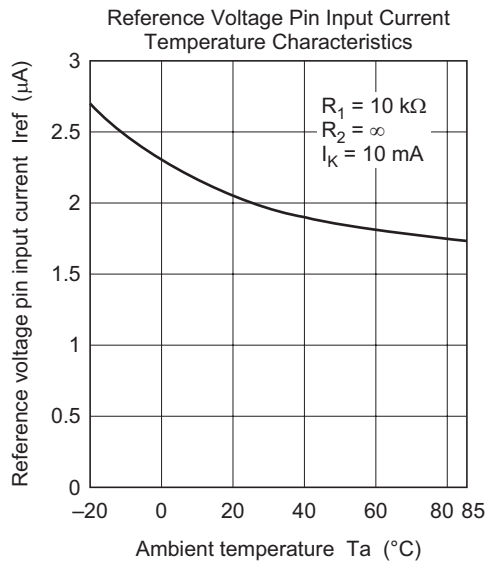

Application Examples

As shown in the figure on the right, this IC operates as an inverting amplifier, with the REF pin as input pin. The open-loop voltage gain is given by the reciprocal of “reference voltage deviation by cathode voltage change” in the electrical specifications, and is approximately 50 to 60 dB. The REF pin has a high input impedance, with an input current I_{ref} of $3.8 \mu\text{A Typ}$ (V version: $I_{ref} = 2 \mu\text{A Typ}$). The output impedance of the output pin K (cathode) is defined as dynamic impedance Z_{KA} , and Z_{KA} is low (0.2Ω) over a wide cathode current range. A (anode) is used at the minimum potential, such as ground.

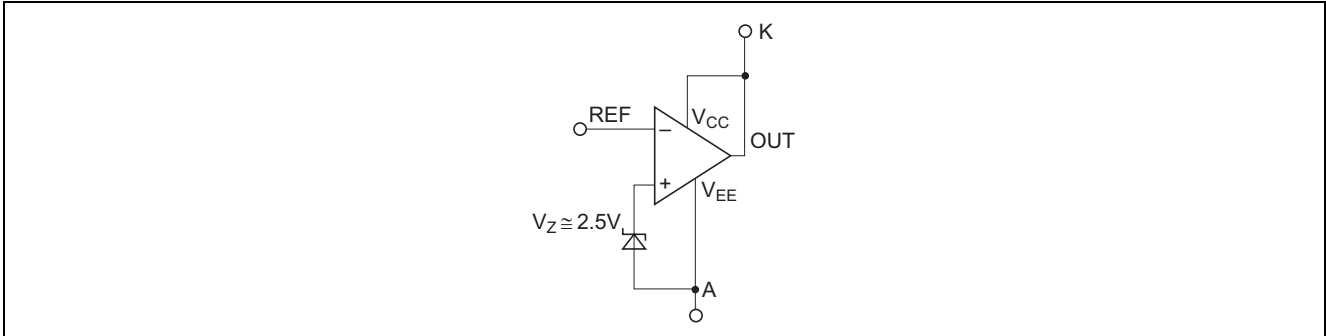
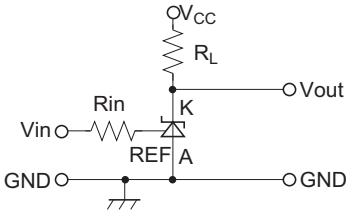
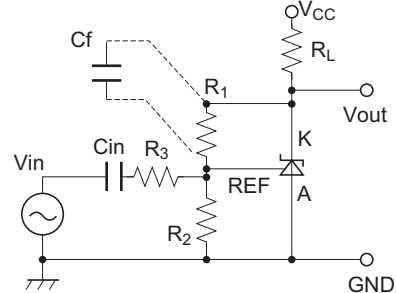
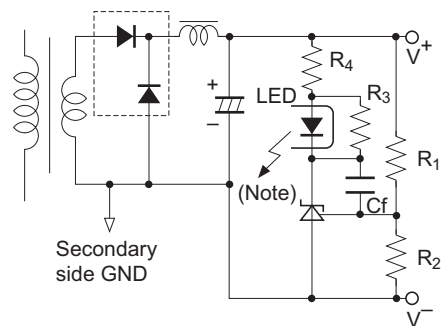

Figure 1 Operation Diagram

Application Hints

| No. | Application Example | Description |
|-----|--|---|
| 1 | <p>Reference voltage generation circuit</p> | <p>This is the simplest reference voltage circuit. The value of the resistance R is set so that cathode current $I_K \geq 1 \text{ mA}$. Output is fixed at $V_{out} \cong 2.5 \text{ V}$. The external capacitor C_L ($C_L \geq 3.3 \mu\text{F}$) is used to prevent oscillation in normal applications.</p> |
| 2 | <p>Variable output shunt regulator circuit</p> | <p>This is circuit 1 above with variable output provided. Here, $V_{out} \cong 2.5 \text{ V} \times \frac{(R_1 + R_2)}{R_2}$. Since the reference input current $I_{ref} = 3.8 \mu\text{A Typ}$ (V version: $I_{ref} = 2 \mu\text{A Typ}$) flows through R_1, resistance values are chosen to allow the resultant voltage drop to be ignored.</p> |

Application Hints (cont.)

| No. | Application Example | Description | | | | | | | | | | | | |
|-----------|---|---|-----------|-----|------|----|----|-----------------|------------------------------------|-----|----|---------------|--------------------------------|----|
| 3 | <p>Single power supply inverting comparator circuit</p>  | <p>This is an inverting type comparator with an input threshold voltage of approximately 2.5 V. Rin is the REF pin protection resistance, with a value of several kΩ to several tens of kΩ.</p> <p>RL is the load resistance, selected so that the cathode current $I_K \geq 1$ mA when Vout is low.</p> <table border="1" data-bbox="711 405 1193 495"> <thead> <tr> <th>Condition</th> <th>Vin</th> <th>Vout</th> <th>IC</th> </tr> </thead> <tbody> <tr> <td>C1</td> <td>Less than 2.5 V</td> <td>V_{CC} (V_{OH})</td> <td>OFF</td> </tr> <tr> <td>C2</td> <td>2.5 V or more</td> <td>Approx. 2 V (V_{OL})</td> <td>ON</td> </tr> </tbody> </table> | Condition | Vin | Vout | IC | C1 | Less than 2.5 V | V _{CC} (V _{OH}) | OFF | C2 | 2.5 V or more | Approx. 2 V (V _{OL}) | ON |
| Condition | Vin | Vout | IC | | | | | | | | | | | |
| C1 | Less than 2.5 V | V _{CC} (V _{OH}) | OFF | | | | | | | | | | | |
| C2 | 2.5 V or more | Approx. 2 V (V _{OL}) | ON | | | | | | | | | | | |
| 4 | <p>AC amplifier circuit</p>  <p>Gain $G = \frac{R_1}{R_2 // R_3}$ (DC gain)</p> <p>Cutoff frequency $f_c = \frac{1}{2\pi C_f (R_1 // R_2 // R_3)}$</p> | <p>This is an AC amplifier with voltage gain $G = -R_1 / (R_2 // R_3)$. The input is cut by capacitance Cin, so that the REF pin is driven by the AC input signal, centered on 2.5 V_{DC}.</p> <p>R2 also functions as a resistance that determines the DC cathode potential when there is no input, but if the input level is low and there is no risk of Vout clipping to V_{CC}, this can be omitted.</p> <p>To change the frequency characteristic, Cf should be connected as indicated by the dotted line.</p> | | | | | | | | | | | | |
| 5 | <p>Switching power supply error amplification circuit</p>  <p>Note: LED : Light emitting diode in photocoupler R3 : Bypass resistor to feed $I_K (> I_{min})$ when LED current vanishes R4 : LED protection resistance</p> | <p>This circuit performs control on the secondary side of a transformer, and is often used with a switching power supply that employs a photocoupler for offlining.</p> <p>The output voltage (between V+ and V-) is given by the following formula:</p> $V_{out} \cong 2.5 \text{ V} \times \frac{(R_1 + R_2)}{R_2}$ <p>In this circuit, the gain with respect to the Vout error is as follows:</p> $G = \frac{R_2}{(R_1 + R_2)} \times \left[\text{HA17431 open loop gain} \right] \times \left[\text{photocoupler total gain} \right]$ <p>As stated earlier, the HA17431 open-loop gain is 50 to 60 dB.</p> | | | | | | | | | | | | |

Application Hints (cont.)

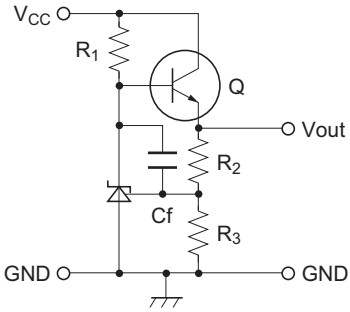
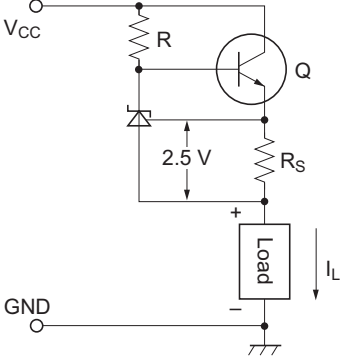
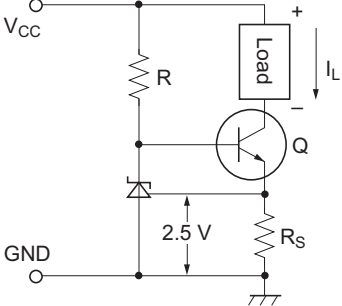
| No. | Application Example | Description |
|-----|--|---|
| 6 | <p>Constant voltage regulator circuit</p>  | <p>This is a 3-pin regulator with a discrete configuration, in which the output voltage</p> $V_{out} = 2.5 \text{ V} \times \frac{(R_2 + R_3)}{R_3}$ <p>R_1 is a bias resistance for supplying the HA17431 cathode current and the output transistor Q base current.</p> |
| 7 | <p>Discharge type constant current circuit</p>  | <p>This circuit supplies a constant current of</p> $I_L \cong \frac{2.5 \text{ V}}{R_S} \text{ [A]}$ <p>into the load. Caution is required since the HA17431 cathode current is also superimposed on I_L. The requirement in this circuit is that the cathode current must be greater than $I_{min} = 1 \text{ mA}$. The I_L setting therefore must be on the order of several mA or more.</p> |
| 8 | <p>Induction type constant current circuit</p>  | <p>In this circuit, the load is connected on the collector side of transistor Q in circuit 7 above. In this case, the load floats from GND, but the HA17431 cathode current is not superimposed on I_L, so that I_L can be kept small (1 mA or less is possible). The constant current value is the same as for circuit 7 above:</p> $I_L \cong \frac{2.5 \text{ V}}{R_S} \text{ [A]}$ |

Design Guide for AC-DC SMPS (Switching Mode Power Supply)

1. Use of Shunt Regulator in Transformer Secondary Side Control

This example is applicable to both forward transformers and flyback transformers. A shunt regulator is used on the secondary side as an error amplifier, and feedback to the primary side is provided via a photocoupler.

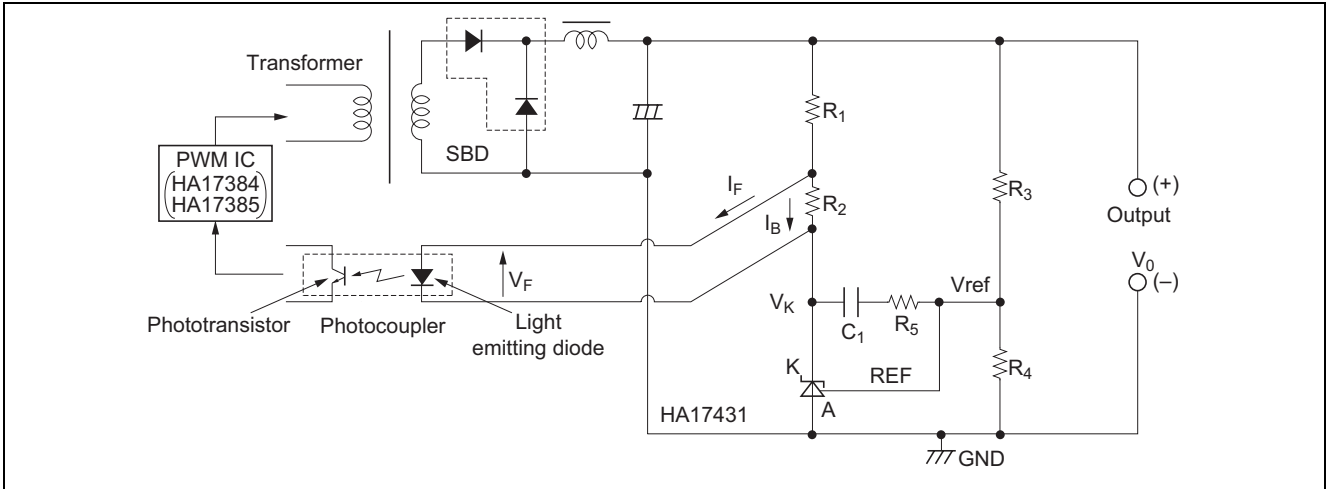

Figure 2 Typical Shunt Regulator/Error Amplifier

2. Determination of External Constants for the Shunt Regulator

A. DC characteristic determination

In figure 2, R₁ and R₂ are protection resistor for the light emitting diode in the photocoupler, and R₂ is a bypass resistor to feed I_K minimum, and these are determined as shown below. The photocoupler specification should be obtained separately from the manufacturer. Using the parameters in figure 2, the following formulas are obtained:

$$R_1 = \frac{V_0 - V_F - V_K}{I_F + I_B}, R_2 = \frac{V_F}{I_B}$$

V_K is the HA17431 operating voltage, and is set at around 3 V, taking into account a margin for fluctuation. R₂ is the current shunt resistance for the light emitting diode, in which a bias current I_B of around 1/5 I_F flows.

Next, the output voltage can be determined by R₃ and R₄, and the following formula is obtained:

$$V_0 = \frac{R_3 + R_4}{R_4} \times V_{ref}, V_{ref} = 2.5 \text{ V Typ}$$

The absolute values of R₃ and R₄ are determined by the HA17431 reference input current I_{ref} and the AC characteristics described in the next section. The I_{ref} value is around 3.8 μA Typ. (V version: 2 μA Typ)

B. AC characteristic determination

This refers to the determination of the gain frequency characteristic of the shunt regulator as an error amplifier. Taking the configuration in figure 2, the error amplifier characteristic is as shown in figure 3.

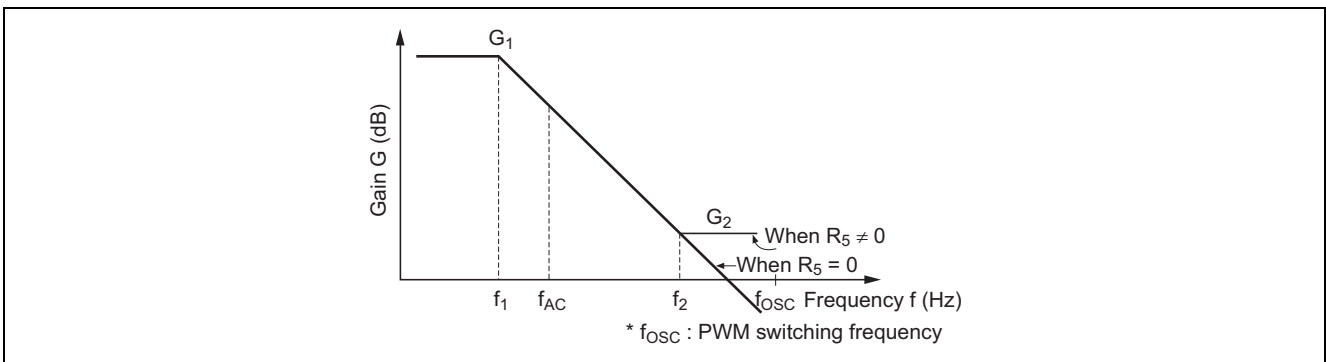

Figure 3 HA17431 Error Amplification Characteristic

In Figure 3, the following formulas are obtained:

Gain

$$G_1 = G_0 \approx 50 \text{ dB to } 60 \text{ dB (determined by shunt regulator)}$$

$$G_2 = \frac{R_5}{R_3}$$

Corner frequencies

$$f_1 = 1/(2\pi C_1 G_0 R_3)$$

$$f_2 = 1/(2\pi C_1 R_5)$$

G_0 is the shunt regulator open-loop gain; this is given by the reciprocal of the reference voltage fluctuation $\Delta V_{\text{ref}}/\Delta V_{\text{KA}}$, and is approximately 50 dB.

3. Practical Example

Consider the example of a photocoupler, with an internal light emitting diode $V_F = 1.05 \text{ V}$ and $I_F = 2.5 \text{ mA}$, power supply output voltage $V_2 = 5 \text{ V}$, and bias resistance R_2 current of approximately $1/5 I_F$ at 0.5 mA . If the shunt regulator $V_K = 3 \text{ V}$, the following values are found.

$$R_1 = \frac{5\text{V} - 1.05\text{V} - 3\text{V}}{2.5\text{mA} + 0.5\text{mA}} = 316(\Omega) \text{ (} 330\Omega \text{ from E24 series)}$$

$$R_2 = \frac{1.05\text{V}}{0.5\text{mA}} = 2.1(\text{k}\Omega) \text{ (} 2.2\text{k}\Omega \text{ from E24 series)}$$

Next, assume that $R_3 = R_4 = 10 \text{ k}\Omega$. This gives a 5 V output. If $R_5 = 3.3 \text{ k}\Omega$ and $C_1 = 0.022 \text{ }\mu\text{F}$, the following values are found.

$$G_2 = 3.3 \text{ k}\Omega / 10 \text{ k}\Omega = 0.33 \text{ times } (-10 \text{ dB})$$

$$f_1 = 1 / (2 \times \pi \times 0.022 \text{ }\mu\text{F} \times 316 \times 10 \text{ k}\Omega) = 2.3 \text{ (Hz)}$$

$$f_2 = 1 / (2 \times \pi \times 0.022 \text{ }\mu\text{F} \times 3.3 \text{ k}\Omega) = 2.2 \text{ (kHz)}$$

Package Dimensions

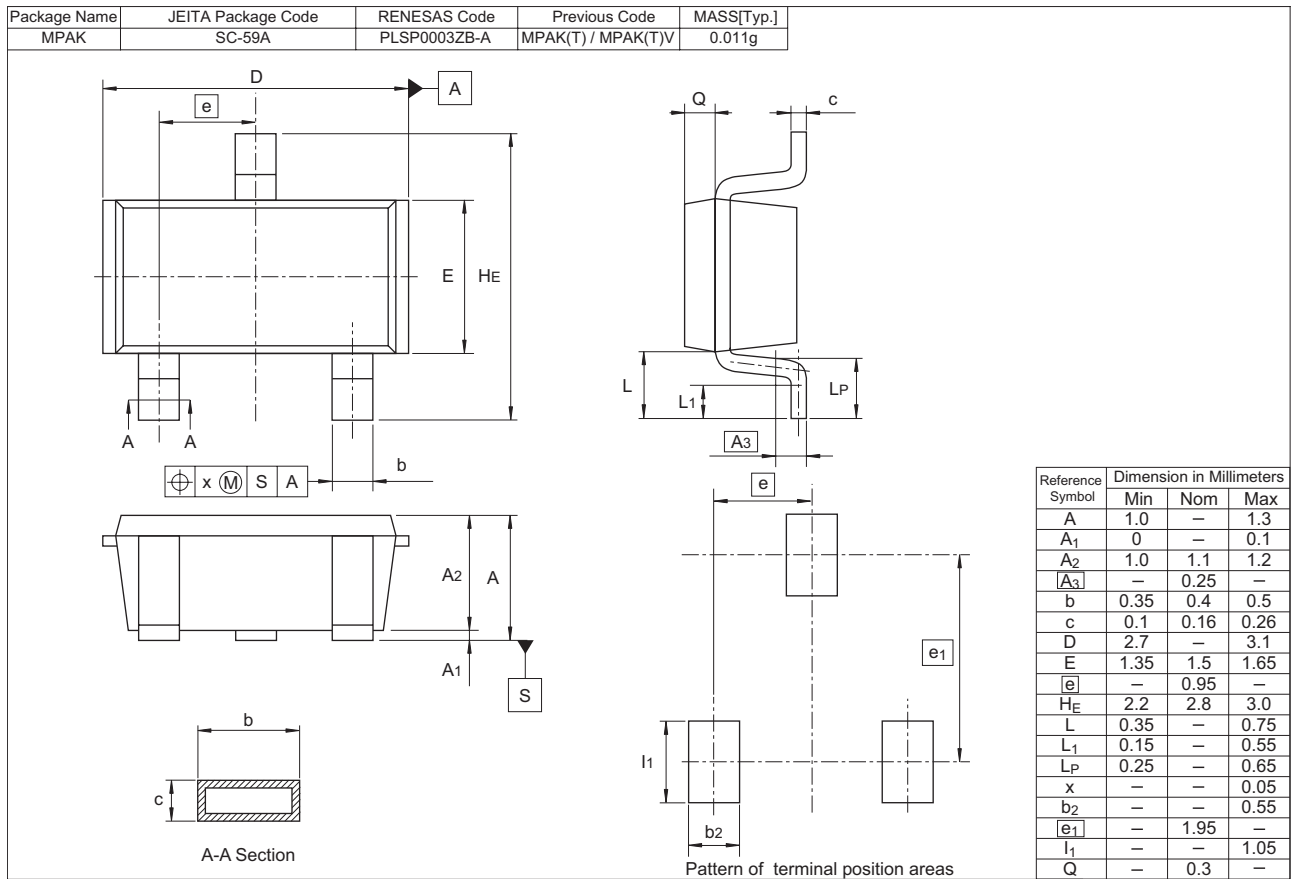
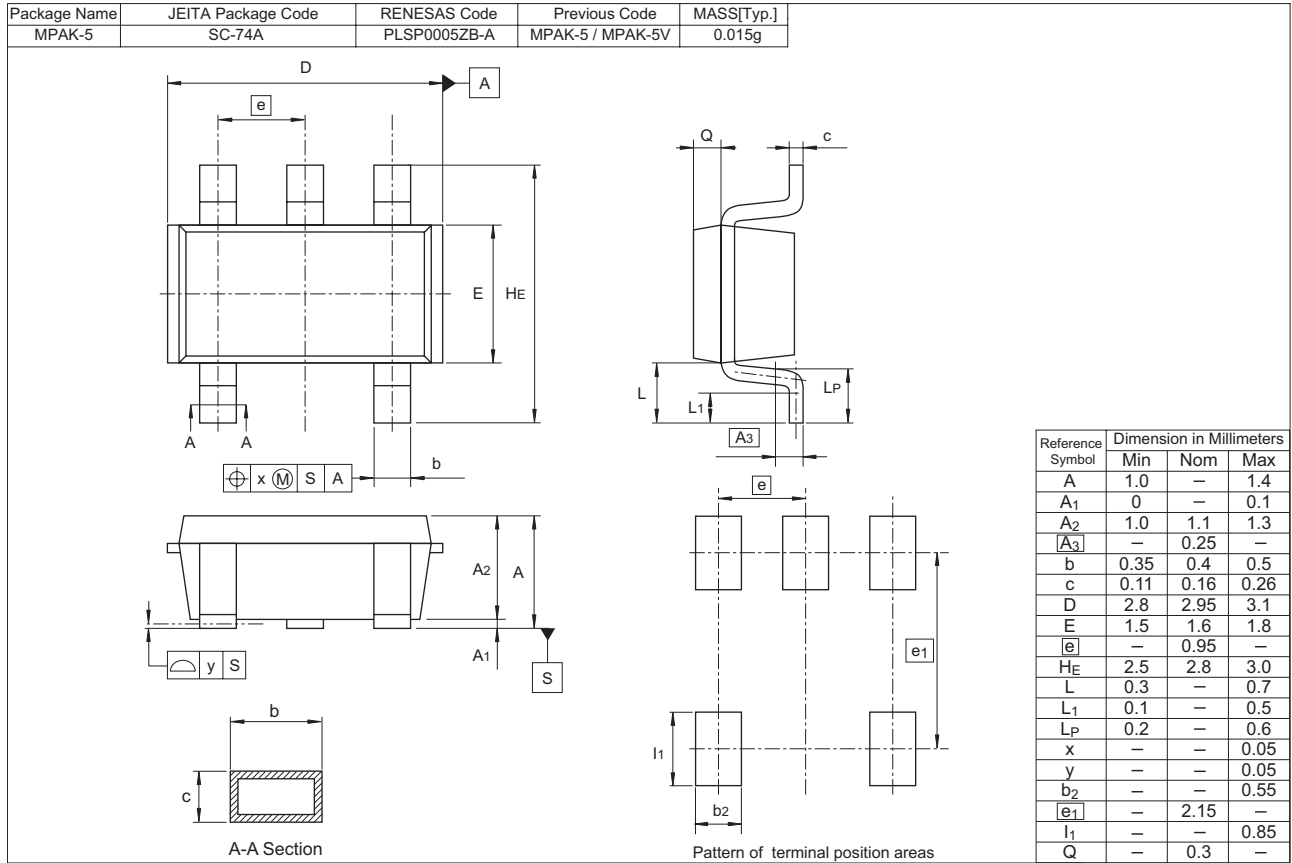

HA17431 Series

| | | | | |
|--------------|--------------------|--------------|---------------|------------|
| Package Name | JEITA Package Code | RENESAS Code | Previous Code | MASS[Typ.] |
| UPAK | SC-62 | PLZZ0004CA-A | UPAK / UPAKV | 0.050g |

Unit: mm

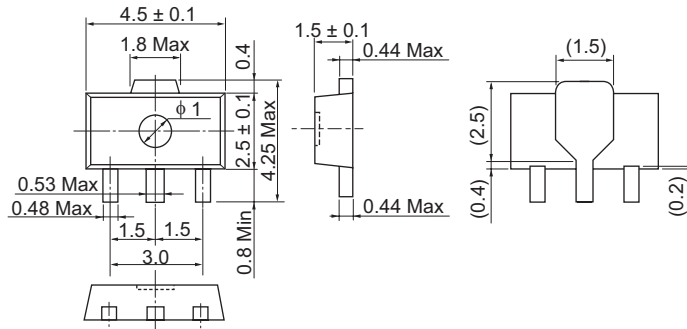

| | | | |
|----------------------|--------------|---------------|------------|
| JEITA Package Code | RENESAS Code | Previous Code | MASS[Typ.] |
| P-SOP8-4.4x4.85-1.27 | PRSP0008DE-B | FP-8DGV | 0.1g |

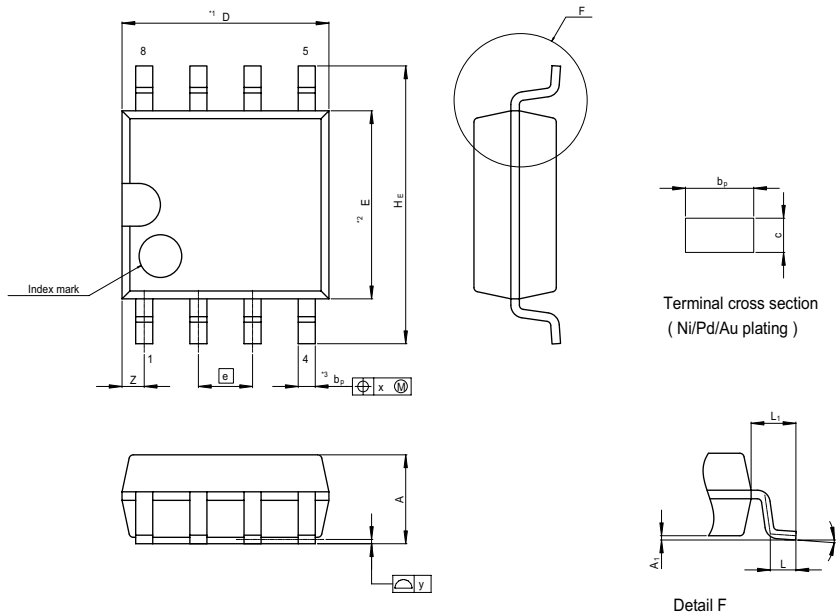

NOTE)
 1. DIMENSIONS**1 (Nom)**AND**2*
 DO NOT INCLUDE MOLD FLASH.
 2. DIMENSION**3*DOES NOT
 INCLUDE TRIM OFFSET.

| Reference Symbol | Dimension in Millimeters | | |
|------------------|--------------------------|------|------|
| | Min | Nom | Max |
| D | — | 4.85 | 5.25 |
| E | — | 4.4 | — |
| A ₂ | — | — | — |
| A ₁ | 0.00 | 0.1 | 0.20 |
| A | — | — | 2.03 |
| b _p | 0.35 | 0.4 | 0.45 |
| b ₁ | — | — | — |
| c | 0.15 | 0.20 | 0.25 |
| c ₁ | — | — | — |
| θ | 0° | — | 8° |
| H _E | 6.35 | 6.5 | 6.75 |
| ⊙ | — | 1.27 | — |
| x | — | — | 0.12 |
| y | — | — | 0.15 |
| Z | — | — | 0.75 |
| L | 0.42 | 0.60 | 0.85 |
| L ₁ | — | 1.05 | — |

HA17431 Series

| Package Name | JEITA Package Code | RENESAS Code | Previous Code | MASS[Typ.] |
|--------------|--------------------|--------------|----------------------|------------|
| TO-92(1) | SC-43A | PRSS0003DA-A | TO-92(1) / TO-92(1)V | 0.25g |

Unit: mm

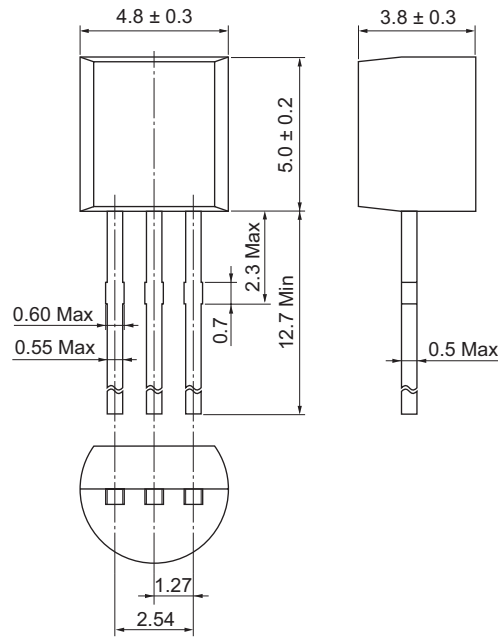

| Package Name | JEITA Package Code | RENESAS Code | Previous Code | MASS[Typ.] |
|--------------|--------------------|--------------|------------------------|------------|
| TO-92 Mod | SC-51 | PRSS0003DC-A | TO-92 Mod / TO-92 ModV | 0.35g |

Unit: mm

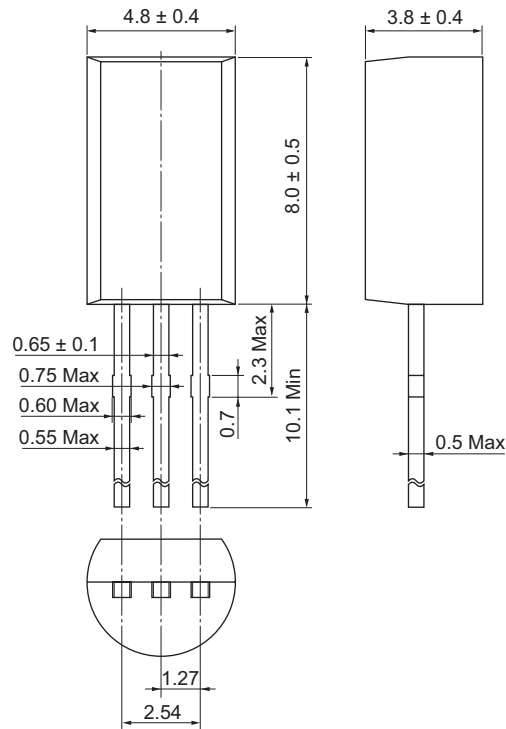

Notes:

1. This document is provided for reference purposes only so that Renesas customers may select the appropriate Renesas products for their use. Renesas neither makes warranties or representations with respect to the accuracy or completeness of the information contained in this document nor grants any license to any intellectual property rights or any other rights of Renesas or any third party with respect to the information in this document.
2. Renesas shall have no liability for damages or infringement of any intellectual property or other rights arising out of the use of any information in this document, including, but not limited to, product data, diagrams, charts, programs, algorithms, and application circuit examples.
3. You should not use the products or the technology described in this document for the purpose of military applications such as the development of weapons of mass destruction or for the purpose of any other military use. When exporting the products or technology described herein, you should follow the applicable export control laws and regulations, and procedures required by such laws and regulations.
4. All information included in this document such as product data, diagrams, charts, programs, algorithms, and application circuit examples, is current as of the date this document is issued. Such information, however, is subject to change without any prior notice. Before purchasing or using any Renesas products listed in this document, please confirm the latest product information with a Renesas sales office. Also, please pay regular and careful attention to additional and different information to be disclosed by Renesas such as that disclosed through our website. (<http://www.renesas.com>)
5. Renesas has used reasonable care in compiling the information included in this document, but Renesas assumes no liability whatsoever for any damages incurred as a result of errors or omissions in the information included in this document.
6. When using or otherwise relying on the information in this document, you should evaluate the information in light of the total system before deciding about the applicability of such information to the intended application. Renesas makes no representations, warranties or guaranties regarding the suitability of its products for any particular application and specifically disclaims any liability arising out of the application and use of the information in this document or Renesas products.
7. With the exception of products specified by Renesas as suitable for automobile applications, Renesas products are not designed, manufactured or tested for applications or otherwise in systems the failure or malfunction of which may cause a direct threat to human life or create a risk of human injury or which require especially high quality and reliability such as safety systems, or equipment or systems for transportation and traffic, healthcare, combustion control, aerospace and aeronautics, nuclear power, or undersea communication transmission. If you are considering the use of our products for such purposes, please contact a Renesas sales office beforehand. Renesas shall have no liability for damages arising out of the uses set forth above.
8. Notwithstanding the preceding paragraph, you should not use Renesas products for the purposes listed below:
 - (1) artificial life support devices or systems
 - (2) surgical implantations
 - (3) healthcare intervention (e.g., excision, administration of medication, etc.)
 - (4) any other purposes that pose a direct threat to human lifeRenesas shall have no liability for damages arising out of the uses set forth in the above and purchasers who elect to use Renesas products in any of the foregoing applications shall indemnify and hold harmless Renesas Technology Corp., its affiliated companies and their officers, directors, and employees against any and all damages arising out of such applications.
9. You should use the products described herein within the range specified by Renesas, especially with respect to the maximum rating, operating supply voltage range, movement power voltage range, heat radiation characteristics, installation and other product characteristics. Renesas shall have no liability for malfunctions or damages arising out of the use of Renesas products beyond such specified ranges.
10. Although Renesas endeavors to improve the quality and reliability of its products, IC products have specific characteristics such as the occurrence of failure at a certain rate and malfunctions under certain use conditions. Please be sure to implement safety measures to guard against the possibility of physical injury, and injury or damage caused by fire in the event of the failure of a Renesas product, such as safety design for hardware and software including but not limited to redundancy, fire control and malfunction prevention, appropriate treatment for aging degradation or any other applicable measures. Among others, since the evaluation of microcomputer software alone is very difficult, please evaluate the safety of the final products or system manufactured by you.
11. In case Renesas products listed in this document are detached from the products to which the Renesas products are attached or affixed, the risk of accident such as swallowing by infants and small children is very high. You should implement safety measures so that Renesas products may not be easily detached from your products. Renesas shall have no liability for damages arising out of such detachment.
12. This document may not be reproduced or duplicated, in any form, in whole or in part, without prior written approval from Renesas.
13. Please contact a Renesas sales office if you have any questions regarding the information contained in this document, Renesas semiconductor products, or if you have any other inquiries.



RENESAS SALES OFFICES

<http://www.renesas.com>

Refer to "<http://www.renesas.com/en/network>" for the latest and detailed information.

Renesas Technology America, Inc.

450 Holger Way, San Jose, CA 95134-1368, U.S.A
Tel: <1> (408) 382-7500, Fax: <1> (408) 382-7501

Renesas Technology Europe Limited

Dukes Meadow, Millboard Road, Bourne End, Buckinghamshire, SL8 5FH, U.K.
Tel: <44> (1628) 585-100, Fax: <44> (1628) 585-900

Renesas Technology (Shanghai) Co., Ltd.

Unit 204, 205, AZIACenter, No.1233 Lujiazui Ring Rd, Pudong District, Shanghai, China 200120
Tel: <86> (21) 5877-1818, Fax: <86> (21) 6887-7898

Renesas Technology Hong Kong Ltd.

7th Floor, North Tower, World Finance Centre, Harbour City, 1 Canton Road, Tsimshatsui, Kowloon, Hong Kong
Tel: <852> 2265-6688, Fax: <852> 2730-6071

Renesas Technology Taiwan Co., Ltd.

10th Floor, No.99, Fushing North Road, Taipei, Taiwan
Tel: <886> (2) 2715-2888, Fax: <886> (2) 2713-2999

Renesas Technology Singapore Pte. Ltd.

1 Harbour Front Avenue, #06-10, Keppel Bay Tower, Singapore 098632
Tel: <65> 6213-0200, Fax: <65> 6278-8001

Renesas Technology Korea Co., Ltd.

Kukje Center Bldg. 18th Fl., 191, 2-ka, Hangang-ro, Yongsan-ku, Seoul 140-702, Korea
Tel: <82> (2) 796-3115, Fax: <82> (2) 796-2145

Renesas Technology Malaysia Sdn. Bhd

Unit 906, Block B, Menara Amcorp, Amcorp Trade Centre, No.18, Jalan Persiaran Barat, 46050 Petaling Jaya, Selangor Darul Ehsan, Malaysia
Tel: <603> 7955-9390, Fax: <603> 7955-9510